

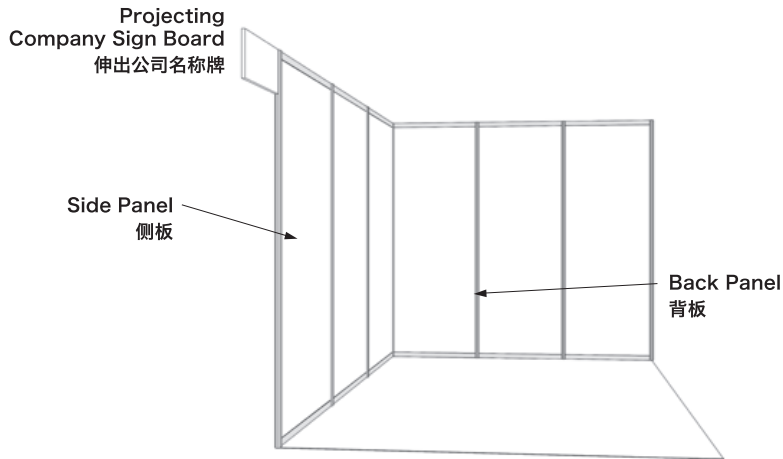

- **Packaged Booths for IPF 2023**
- **Information about rental equipment**

Organizer / IPF Association
主辦單位 / 國際塑橡膠展覽協會



Basic Booth Unit 关于基础展位

◆ Items included in the exhibition fee
◆ 包含在参展费用之内

- Side Panel ○ Back Panel
- Projecting Company Sign Board
- 背板 ○ 侧板 ○ 伸出公司名称牌

System Panels 面板系统说明

Package booths efficiently use the panel system of the basic unit.

组合式展位有效利用基础展位的系统面板。

- System panels are made of PVC boards (white), aluminum poles and aluminum beams.
- An aluminum pole is installed every 1 meter.
- You will not be able to pin thumb tacks, use nails, adhesives or wall paper on the veneer wall (4mm).

- 系统面板由白色PVC面板、铝合金支柱及铝合金横梁构成。
- 在约每1米间距的壁面面板之间设有铝合金支柱。
- 在作为壁面的厚度4mm面板饰面不可按入图钉、打入钉子等，不可使用粘接剂，不可直接张贴墙纸。

● Elevation view of the basic booth unit/ aluminum pole installed every 1 meter.
● 基础展位立面图 / 每1米间距的壁面面板之间设有铝合金支柱。

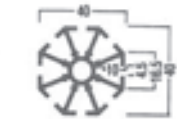
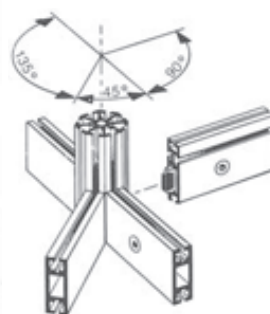
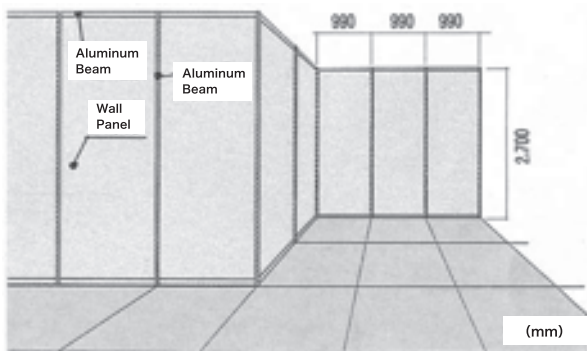

● Aluminum Pole



● Aluminum Beam

Installation of Poster Panels 展板等的安装说明

There are 2 ways to install the poster panels.

- Hang with S shaped hooks, chains or fishing line (synthetic fiber threads).
- Attach panels to the wall surface using Velcro tape. (Please consult our staff if you have any questions or concerns.)

展板安装有如下两种方法。

- 用S型挂钩、链条或绳子等吊起。
- 用魔力胶带粘在壁面上。(如有不明之处请咨询工作人员)

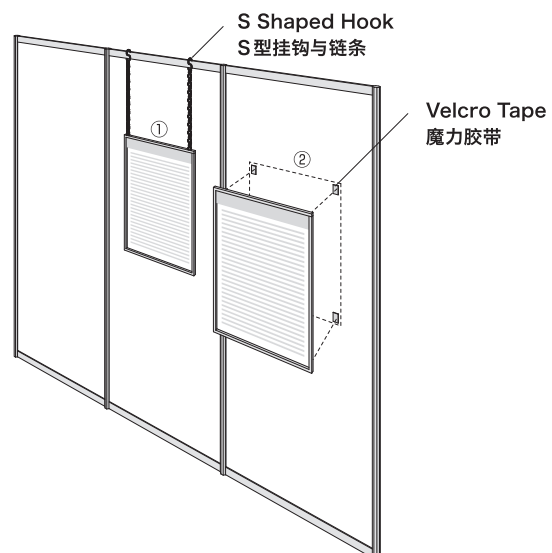

Packaged Booth (1 Side Open)	
● Fascia Board × 3m	
● Punch Carpet × 1	
● Designated Wall Color × 9	
● LED Fluorescent Lamps (21W) × 2	
● 100V Outlet (2 Ports) × 1	
※Capacity: 900W	
● Reception Counter × 1	
● Chair × 1	
● Business Card Box × 1	
● Company Name Sign × 1	
● Electricity Supply & Wiring (1.0kw)	
Total Cost	¥11,900 (tax included)

Packaged Booth Corner (2 Side Open)	
● Fascia Board × 6m	
● Punch Carpet × 1	
● Designated Wall Color × 6	
● LED Fluorescent Lamps (21W) × 4	
● 100V Outlet (2 Ports) × 1	
※Capacity: 900W	
● Reception Counter × 1	
● Chair × 1	
● Business Card Box × 1	
● Company Name Sign × 2	
● Electricity Supply & Wiring (1.0kw)	
Total Cost	¥138,600 (tax included)

组合式展位 中小房间	
● 楣板 × 3m	
● 地毯 × 1	
● 指定壁面颜色 × 9	
● LED日光灯 (21W) × 2	
● 100V 插座 (二插孔) × 1	
※ 插座容量 : 900W	
● 洽谈桌 × 1	
● 椅子 × 1	
● 名片盒 × 1	
● 公司名称牌 × 1	
● 干线电源布线及供电 (1.0kW)	
合计金额	¥119,900 (含税)

组合式展位 角小房间	
● 楣板 × 6m	
● 地毯 × 1	
● 指定壁面颜色 × 6	
● LED日光灯 (21W) × 4	
● 100V 插座 (二插孔) × 1	
※ 插座容量 : 900W	
● 洽谈桌 × 1	
● 椅子 × 1	
● 名片盒 × 1	
● 公司名称牌 × 2	
● 干线电源布线及供电 (1.0kW)	
合计金额	¥138,600 (含税)

(Example : Packaged Booth Corner)
(例 : 角小房间)

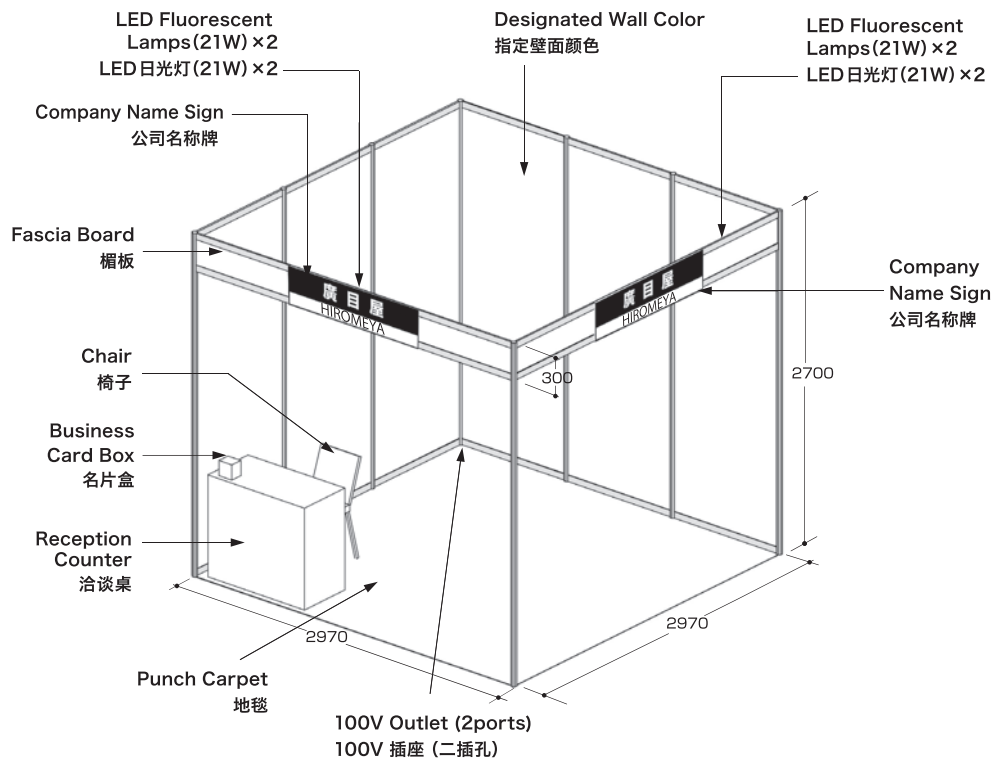

Decoration Package (Standard Booth) Single Row : 2 Units 装饰组合式(标准展位用)单排: 2个展位

Pakaged Booth (1 Side Open)	Pakaged Booth Corner (2 Side Open)	Pakaged Booth(3 Side Open)
<ul style="list-style-type: none"> ● Fascia Board × 6m ● Punch Carpet × 2 ● Designated Wall Color × 12 ● LED Fluorescent Lamps (21W) × 4 ● 100V Outlet (2 Ports) × 1 ※Capacity: 1500W ● Reception Counter × 1 ● Chair × 1 ● Business Card Box × 1 ● Company Name Sign × 1 ● Electricity Supply & Wiring (2.0kw) 	<ul style="list-style-type: none"> ● Fascia Board × 9m ● Punch Carpet × 2 ● Designated Wall Color × 9 ● LED Fluorescent Lamps (21W) × 6 ● 100V Outlet (2 Ports) × 1 ※Capacity: 1500W ● Reception Counter × 1 ● Chair × 1 ● Business Card Box × 1 ● Company Name Sign × 2 ● Electricity Supply & Wiring (2.0kw) 	<ul style="list-style-type: none"> ● Fascia Board × 12m ● Punch Carpet × 2 ● Designated Wall Color × 6 ● LED Fluorescent Lamps (21W) × 8 ● 100V Outlet (2 Ports) × 1 ※Capacity: 1500W ● Reception Counter × 1 ● Chair × 1 ● Business Card Box × 1 ● Company Name Sign × 3 ● Electricity Supply & Wiring (2.0kw)
Total Cost ¥193,600 (tax included)	Total Cost ¥209,000 (tax included)	Total Cost ¥226,600 (tax included)
组合式展位 中小房间	组合式展位 角小房间	组合式展位 两空间小房间
<ul style="list-style-type: none"> ● 楣板 × 6m ● 地毯 × 2 ● 指定壁面颜色 × 12 ● LED日光灯 (21W) × 4 ● 100V插座 (二插孔) × 1 ※ 插座容量: 1500W ● 洽谈桌 × 1 ● 椅子 × 1 ● 名片盒 × 1 ● 公司名称牌 × 1 ● 干线电源布线及供电 (2.0kW) 	<ul style="list-style-type: none"> ● 楣板 × 9m ● 地毯 × 2 ● 指定壁面颜色 × 9 ● LED日光灯 (21W) × 6 ● 100V插座 (二插孔) × 1 ※ 插座容量: 1500W ● 洽谈桌 × 1 ● 椅子 × 1 ● 名片盒 × 1 ● 公司名称牌 × 2 ● 干线电源布线及供电 (2.0kW) 	<ul style="list-style-type: none"> ● 楣板 × 12m ● 地毯 × 2 ● 指定壁面颜色 × 6 ● LED日光灯 (21W) × 8 ● 100V插座 (二插孔) × 1 ※ 插座容量: 1500W ● 洽谈桌 × 1 ● 椅子 × 1 ● 名片盒 × 1 ● 公司名称牌 × 3 ● 干线电源布线及供电 (2.0kW)
合计金额 ¥193,600 (含税)	合计金额 ¥209,000 (含税)	合计金额 ¥226,600 (含税)

(Example : Pakaged Booth Corner)
(例: 角小房间)

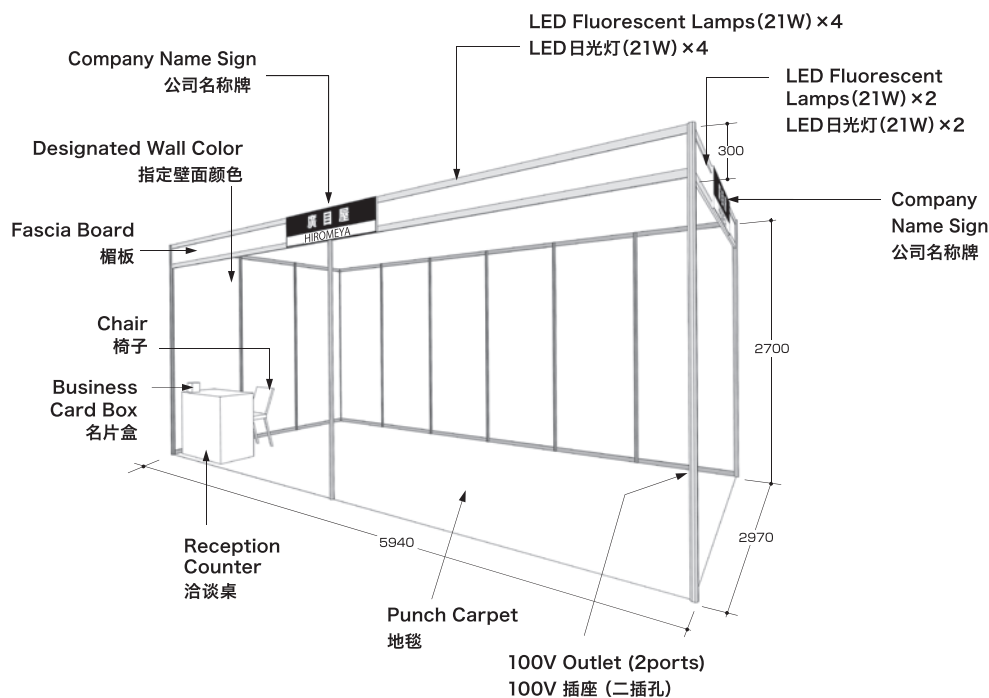

Items	Single Row						
	1 Unit		2 Units			3 Units	
	1 Side Open	2 Side Open(Corner)	1 Side Open	2 Side Open(Corner)	3 Side Open	2 Side Open(Corner)	3 Side Open
Fascia Board	3m	6m	6m	9m	12m	12m	15m
Punch Carpet	1 Unit	1 Unit	2 Units	2 Units	2 Units	3 Units	3 Units
Color (Wall Panel)	9	6	12	9	6	12	9
LED Fluorescent Lamps (21W)	2	4	4	6	8	8	10
100V Outlet (2 Ports)	1	1	1	1	1	1	1
Capacity	900W	900W	1500W	1500W	1500W	1500W	1500W
Reception Counter	1	1	1	1	1	1	1
Chair	1	1	1	1	1	1	1
Business Card Box	1	1	1	1	1	1	1
Company Name Sign	1	2	1	2	3	2	3
Electricity Supply & Wiring	1.0kw	1.0kw	2.0kw	2.0kw	2.0kw	3.0kw	3.0kw
Total Cost (Tax Included)	¥119,900	¥138,600	¥193,600	¥209,000	¥226,600	¥280,500	¥300,300

*Construction costs for additional wiring installations will be charged separately.

装饰组合式(标准展位用)展位价格表

施工项目	单排						
	1个展位		2个展位			3个展位	
	中小房间	角小房间	中小房间	角小房间	两空间小房间	角小房间	两空间小房间
楣板	3m	6m	6m	9m	12m	12m	15m
地毯	1个展位	1个展位	2个展位	2个展位	2个展位	3个展位	3个展位
指定壁面颜色	9	6	12	9	6	12	9
LED日光灯(21W)	2盏	4盏	4盏	6盏	8盏	8盏	10盏
100V插座(二插孔)	1处	1处	1处	1处	1处	1处	1处
插座容量	900W	900W	1500W	1500W	1500W	1500W	1500W
洽谈桌	1个	1个	1个	1个	1个	1个	1个
椅子	1张	1张	1张	1张	1张	1张	1张
名片盒	1个	1个	1个	1个	1个	1个	1个
公司名称牌	1组	2组	1组	2组	3组	2组	3组
干线电源布线及供电	1.0kw	1.0kw	2.0kw	2.0kw	2.0kw	3.0kw	3.0kw
合计金额(含税)	¥119,900	¥138,600	¥193,600	¥209,000	¥226,600	¥280,500	¥300,300

*如超过干线电源布线范围, 将另行收费。

Decoration Package (Standard Booth) Price List

Items	Single Row						Double Row	
	4 Unit		5 Unit		6 Units		4 Units	6 Units
	2 Side Open(Corner)	3 Side Open	2 Side Open(Corner)	3 Side Open	2 Side Open(Corner)	3 Side Open	3 Side Open	3 Side Open
Fascia Board	15m	18m	18m	21m	21m	24m	18m	24m
Punch Carpet	4 Units	4 Units	5 Units	5 Units	6 Units	6 Units	4 Units	6 Units
Color (Wall Panel)	15	12	18	15	21	18	6	6
LED Fluorescent Lamps (21W)	10	12	12	14	14	16	12	16
100V Outlet (2 Ports)	1	1	1	1	1	1	1	1
Capacity	1500W	1500W	1500W	1500W	1500W	1500W	1500W	1500W
Reception Counter	1	1	1	1	1	1	1	1
Chair	1	1	1	1	1	1	1	1
Business Card Box	1	1	1	1	1	1	1	1
Company Name Sign	2	3	2	3	2	3	3	3
Electricity Supply & Wiring	4.0kw	4.0kw	5.0kw	5.0kw	6.0kw	6.0kw	4.0kw	6.0kw
Total Cost (Tax Included)	¥357,500	¥375,100	¥430,100	¥446,600	¥507,100	¥522,500	¥347,600	¥473,000

*Construction costs for additional wiring installations will be charged separately.

装饰组合式(标准展位用)展位价格表



施工项目	单排						两排	
	4个展位		5个展位		6个展位		4个展位	6个展位
	角小房间	两空间小房间	角小房间	两空间小房间	角小房间	两空间小房间	两空间小房间	两空间小房间
楣板	15m	18m	18m	21m	21m	24m	18m	24m
地毯	4个展位	4个展位	5个展位	5个展位	6个展位	6个展位	4个展位	6个展位
指定墙面颜色	15	12	18	15	21	18	6	6
LED日光灯(21W)	10盏	12盏	12盏	14盏	14盏	16盏	12盏	16盏
100 V插座(二插孔)	1处	1处	1处	1处	1处	1处	1处	1处
插座容量	1500W	1500W	1500W	1500W	1500W	1500W	1500W	1500W
洽谈桌	1个	1个	1个	1个	1个	1个	1个	1个
椅子	1张	1张	1张	1张	1张	1张	1张	1张
名片盒	1个	1个	1个	1个	1个	1个	1个	1个
公司名称牌	2组	3组	2组	3组	2组	3组	3组	3组
干线电源布线及供电	4.0kw	4.0kw	5.0kw	5.0kw	6.0kw	6.0kw	4.0kw	6.0kw
合计金额(含税)	¥357,500	¥375,100	¥430,100	¥446,600	¥507,100	¥522,500	¥347,600	¥473,000

*如超过干线电源布线范围, 将另行收费。

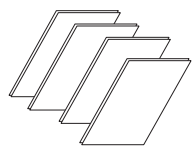
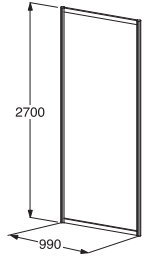
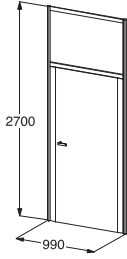
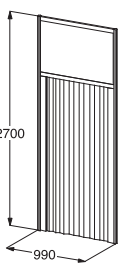
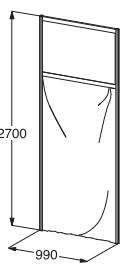
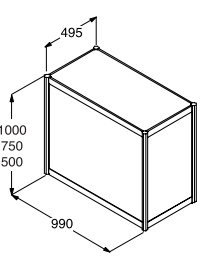
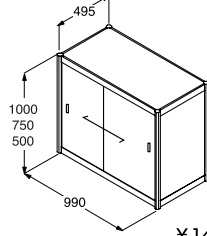
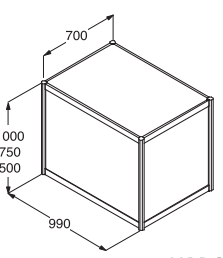
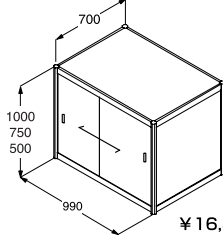
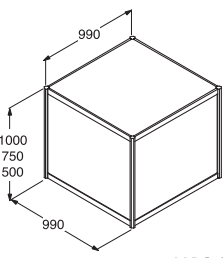
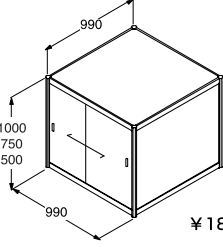

Please select from below.
请选择需要的用品。

*Tax is included in the price.
金额已包含消费税

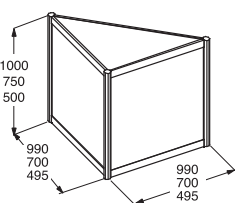
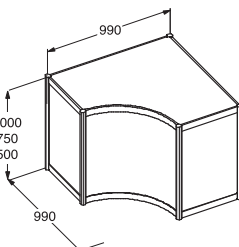
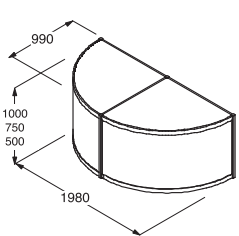
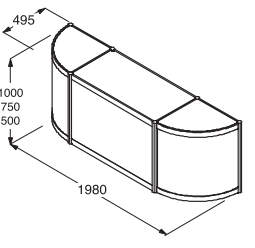
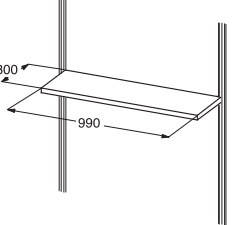
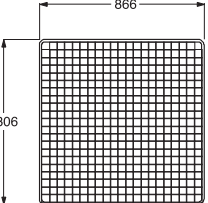
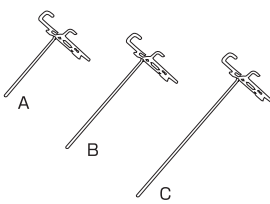
<p>1 S-shaped Hooks & Chains 链条与挂钩</p>  <p>Chain(1m)×2 S-type Hook×4</p> <p>1set ¥550</p>	<p>2 Velcro Tape 魔力胶带</p>  <p>1set(4 tapes) ¥550</p>	<p>3 Additional Wall Panel PVC面板</p>  <p>2700 990</p> <p>¥7,700</p>	<p>4 Door 门</p>  <p>2700 990</p> <p>¥24,200</p>
<p>5 Accordion Door 折叠门</p>  <p>2700 990</p> <p>¥24,200</p>	<p>6 Curtain 窗帘</p>  <p>2700 990</p> <p>¥11,000</p>	<p>7 Display Stand 展台</p>  <p>495 1000 750 500 990</p> <p>¥8,800</p>	<p>8 Display Stand with Sliding Door 展台带锁拉门</p>  <p>495 1000 750 500 990</p> <p>¥14,300</p> <p>*This display stand does not come with a key. *这个展示架没有锁。</p>
<p>9 Display Stand 展台</p>  <p>700 1000 750 500 990</p> <p>¥11,000</p>	<p>10 Display Stand with Sliding Door 展台带锁拉门</p>  <p>700 1000 750 500 990</p> <p>¥16,500</p> <p>*This display stand does not come with a key. *这个展示架没有锁。</p>	<p>11 Display Stand 展台</p>  <p>990 1000 750 500 990</p> <p>¥13,200</p>	<p>12 Display Stand with Sliding Door 展台带锁拉门</p>  <p>990 1000 750 500 990</p> <p>¥18,700</p> <p>*This display stand does not come with a key. *这个展示架没有锁。</p>
<p>13 Display Stand key 展示架钥匙</p>  <p>¥1,100</p> <p>* If you would like a display stand with a key, please order here. * 如果您想要带钥匙的展示架, 请在这里订购。</p>	<p>14 Display Stand 展台</p>  <p>1000 750 500 990 700 495 990 700 495</p> <p>W990×D990 ¥9,350 W700×D700 ¥8,250 W495×D495 ¥7,150</p>	<p>15 Display Stand 展台</p>  <p>990 1000 750 500 990</p> <p>¥19,800</p>	<p>16 Display Stand 展台</p>  <p>990 1000 750 500 1980</p> <p>¥22,000</p>
<p>17 Display Stand 展台</p>  <p>495 1000 750 500 1980</p> <p>¥23,100</p>	<p>18 Shelf 搁板</p>  <p>300 990</p> <p>¥2,750</p>	<p>19 Wire Mesh 网状挂物架</p>  <p>866 1306</p> <p>¥8,250</p>	<p>20 Hook 各种挂钩</p>  <p>A B C</p> <p>A: L100 m/m ¥176 B: L150 m/m ¥176 C: L200 m/m ¥264</p>

Optional Electrical Appliance 电器用品的选择

Please select from below.
请选择需要的用品。

*Tax is included in the price.
*金额已包含消费税

21 LED Spotlight LED 聚光灯	22 LED Spotlight with Arm LED 长臂聚光灯	23 LED Light (60W) LED 灯 (60W)	24 LED Light (100W) LED 灯 (100W)												
 LED(15W) ¥3,300 *Cost of installation and electricity usage is not included. *干线电源布线另行收费。	 LED(15W) ¥3,850 *Cost of installation and electricity usage is not included. *干线电源布线另行收费。	 ¥13,750 *Cost of installation and electricity usage is not included. *干线电源布线另行收费。	 ¥16,500 *Cost of installation and electricity usage is not included. *干线电源布线另行收费。												
25 LED Florescent Lamp (21W) LED 日光灯	26 100V Outlet 插座	27 100V Three Phase Outlet 三相插座	28 Distribution Box fee 配电板建设费												
 Fluorescent Lamp (21W) ¥3,300 *Cost of installation and electricity usage is not included. *干线电源布线另行收费。	 ¥3,300 *Cost of installation and electricity usage is not included. *干线电源布线另行收费。	 ¥3,850 *Cost of installation and electricity usage is not included. *干线电源布线另行收费。	<table border="1"> <thead> <tr> <th>Number of lines 线路数量</th> <th>Capacity 容量</th> <th>Price 金额</th> </tr> </thead> <tbody> <tr> <td>One line 1条线路</td> <td>~1,500W</td> <td>—</td> </tr> <tr> <td>Two lines 2条线路</td> <td>1,501W~3,000W</td> <td>¥7,700</td> </tr> <tr> <td>Three lines 3条线路</td> <td>3,001W~4,500W</td> <td>¥11,550</td> </tr> </tbody> </table> <p>The cost of each additional line is ¥3,850. 之后,每增加1条线路加收3,850日元(含税)。</p>	Number of lines 线路数量	Capacity 容量	Price 金额	One line 1条线路	~1,500W	—	Two lines 2条线路	1,501W~3,000W	¥7,700	Three lines 3条线路	3,001W~4,500W	¥11,550
Number of lines 线路数量	Capacity 容量	Price 金额													
One line 1条线路	~1,500W	—													
Two lines 2条线路	1,501W~3,000W	¥7,700													
Three lines 3条线路	3,001W~4,500W	¥11,550													

Optional Electrical Appliance 电器用品的选择

- LED Spotlight ●LED Spotlight with Arm ●LED Light
- LED Florescent Lamp ●Outlet (100V)
- 聚光灯 ●长臂聚光灯 ●日光灯 ●插座(100V)

-
- * Please note that the rental price of electrical fixtures does not include the cost of installation and electricity usage.
 - * The following charges will be added as construction costs for circuit box installation. Please notify us in advance if you wish to use refrigerators and other appliances that require electricity 24 hours a day.
 - * Please indicate required wattage and usage of your electrical outlet.

- * 电器用品的租赁金额不包括干线电源布线及电费, 请加以注意。
- * 分电盘的施工收费如下所示。此外, 冰箱等需要24小时供电时, 请事前告知。
- * 插座请填写使用目的及消费电力容量。

Outline of Rental Furniture Application 展具增租申请要领

Note to be checked when applying 申请时的确认事项

- 1) The exhibitor who needs the additional furniture should submit the application of rental furniture by e-mail.
Az Scene Corporation will send the invoice as the order confirmation within a week after receipt of application.
请先把《展具申请表格》e-mail 给我们，经确认后，一周以内我们会发去帐单。
- 2) Rental items may differ slightly from the photo in the catalogue depending upon the stock status.
根据库存情况，实际的商品会和目录图片有所差异，望谅解！

Change and Cancellation 更改和取消

- 1) The addition, the change, and the application of rental furniture during the construction and the exhibition period are accepted at the Az Scene Corporation's counter in the hall on-site.
In those cases, the payment is required to be made on-site.
在布展期间，如有需要增加或者更改展具，可以在现场株式会社 Az Scene 办公柜台上申请。
* 费用将在展期中征收。
- 2) In case that the application is cancelled, please acknowledge of taking about one month for the refund after the exhibition ends.
申请后如果取消，退款手续需要在展会结束后一个月左右，望谅解！
- 3) It is also the same rule of the refund for the balance of cancellation.
取消其中一部分的退款手续也和上条相同。
- 4) Cancellation of rental furniture during the exhibition cannot be accepted.
开展以后不可再取消，请谅解！

Rental Fee 租借费用中包括的内容

- 1) Price covers the fee to lease, bring-in /-out, and install the furniture in your booth.
租借费用中包括展期中的租借费用，运输费用和展位里的设置费用。

Furniture on our website are also available. Please refer to www.azscene.co.jp . If you would like to order, please write item, item No. and quantity in the remarks column on the application form.

除了附页上介绍的展具以外，您也可以在本公司网站 www.azscene.co.jp 上挑选。请在《展具租用申请表》中的备注栏中填入商品号码和数量。

Inquiry / Submit to 查询及表格的提交

Az Scene Corporation 株式会社 Az Scene

Contact : Ms.Junko Taniguchi

E-mail : junko-t@azscene.co.jp

Tel : +81-3-5368-1961 Fax : +81-3-5368-1968

Rental Furniture (1)

*10% consumption tax included

<p>1 Meeting table & chairs</p>  <p>White ¥11,000</p>	<p>2 Meeting table & chairs</p>  <p>Black ¥15,950</p>	<p>3 Meeting table & chairs</p>  <p>White ¥20,350</p>	<p>4 Meeting table & chairs</p>  <p>Black ¥20,350</p>
<p>5 Meeting table & chairs</p>  <p>¥14,300</p>	<p>6 Table</p>  <p>W1800/D600/H700 ¥3,850</p>	<p>7 Table</p>  <p>W1500/D600/H700 ¥3,850</p>	<p>8 Table</p>  <p>W1200/D600/H700 ¥3,850</p>
<p>9 Square table</p>  <p>W750/D450/H650 ¥2,200</p>	<p>10 Square table</p>  <p>W450/D450/H650 ¥2,200</p>	<p>11 Round table</p>  <p>(A) ø 750/H650 (B) ø 600/H650 ¥4,400</p>	<p>12 Unit counter</p>  <p>(A)W1800/D700/H750 ¥20,900 (B)W1500/D600/H750 ¥14,300 (C)W1200/D600/H750 ¥13,200</p>
<p>13 Reception counter</p>  <p>W900/D450/H750 ¥6,600</p>	<p>14 Reception counter</p>  <p>W1200/D600/H985 (A) White (B) Black (C) Grain ¥22,000</p>	<p>15 Reception chair</p>  <p>SH750 ¥3,850</p>	<p>16 Reception chair</p>  <p>SH600 ¥3,850</p>
<p>17 Reception chair</p>  <p>SH500 ¥3,850</p>	<p>18 Café chair</p>  <p>White ¥3,300</p>	<p>19 Café chair</p>  <p>Black ¥3,300</p>	<p>20 Folding chair</p>  <p>¥660</p>

Rental Furniture (2)

*10% consumption tax included

<p>21 Catalogue stand</p>  <p>A4/12columns ¥6,050</p>	<p>22 Catalogue stand</p>  <p>Desktop ¥1,650</p>	<p>23 Panel stand</p>  <p>¥2,750</p>	<p>24 LED light frame</p>  <p>(A) A1/594x841 ¥19,800 (B) A2/420x594 ¥15,400 (C) A3/297x420 ¥13,200</p>
<p>25 Business card box</p>  <p>¥1,650</p>	<p>26 Island case</p>  <p>(A) W900/D600/H900 (B) W900/D600/H750 ¥18,700</p>	<p>27 Showcase</p>  <p>(A) W1800/D600/H920 ¥20,900 (B) W1500/D600/H920 ¥17,600 (C) W1200/D600/H920 ¥14,300</p>	<p>28 Single hanger</p>  <p>¥3,300</p>
<p>29 Coat hanger</p>  <p>¥4,400</p>	<p>30 Hanger</p>  <p>¥165</p>	<p>31 Dust box</p>  <p>Large ¥2,750</p>	<p>32 Dust box</p>  <p>Medium ¥715</p>
<p>33 Refrigerator</p>  <p>(A) L ¥22,000 (B) M ¥16,500 (C) S ¥14,300</p>	<p>34 Coffee machine</p>  <p>¥22,940</p>	<p>35 Vacuum cleaner</p>  <p>¥11,000</p>	<p>36 Steel shelf</p>  <p>W900/D300/H1800 ¥7,150</p>
<p>37 Fire extinguisher</p>  <p>¥4,400</p>	<p>38 White cloth</p>  <p>W2000/D900 ¥1,320</p>	<p>39 Plant</p>  <p>(A) Large/H1700 ¥4,950 (B) Medium/H700 ¥3,850 (C) Small/H300 ¥2,750 (D) Flower pot/H300 ¥2,750</p>	<p>40 Display set</p>  <p>42inch Display + DVD player + Stand</p>



Contact

Booth Decoration

HIROMEYA Co.,Ltd. Mr.Igata

1-6-1, GINZA, CHUO-KU, TOKYO 〒104-0061, JAPAN

TEL +81-3-3563-0018 FAX +81-3-3563-0023

E-mail : ipf-en@hiromeya.co.jp

Rental Furniture

AZ Scene Corporation

Ms.Junko Taniguchi

10-8, YOCHOMACHI, SHINJUKU-KU, TOKYO 〒162-0055, JAPAN

TEL +81-3-5368-1961 FAX +81-3-5368-1968

E-mail : junko-t@azscene.co.jp

色見本 Color Sample

■ 壁面カラー / パラペット / 社名サイン WALL COLOR / LETTER COLOR

101 白 White

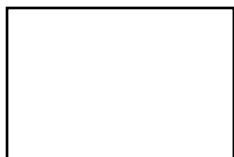

402 ピンク Pink



201 水色 Light blue



503 クリーム Cream



701 黄緑 Yellow green



107 グレー Gray



408 赤 Red



206 青 Blue



604 黄色 Yellow



704 緑 Green



111 黒 Black



410 濃い赤 Deep red



210 紺 Navy



504 オレンジ Orange



705 深緑 Deep green



■ カーペット CARPET COLOR

05 グレー Gray

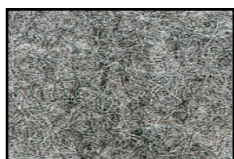

31 ピンク Pink

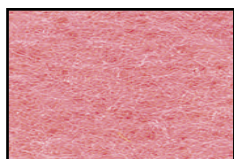

43 水色 Light blue

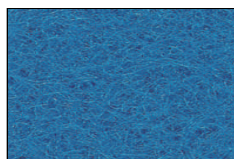

60 黄色 Yellow

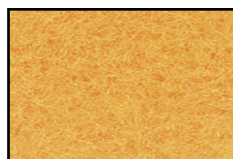

28 黄緑 Yellow green

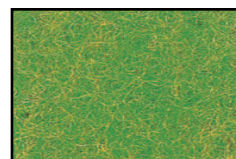

04 黒 Black



01 赤 Red



23 青 Blue

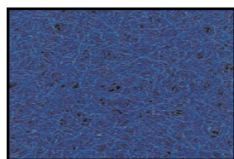

13 オレンジ Orange

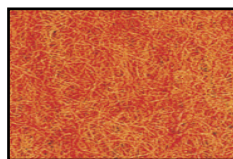

20 緑 Green

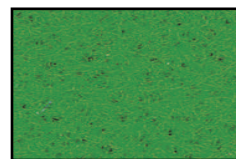

69 紫 Purple

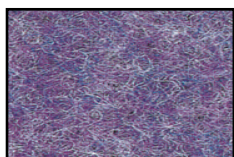

02 濃い赤 Deep red

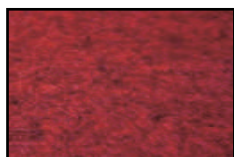

12 紺 Navy

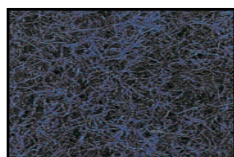

19 茶色 Brawn



03 深緑 Deep green

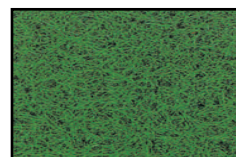

※色見本の色と実際の色が若干異なることがあります。